

Robert Bosch GmbH
Power Tools Division
70745 Leinfelden-Echterdingen
Germany

www.bosch-pt.com

1 619 P07 577 (2009.10) O / 211 WEU



1 619 P07 577

GWS Professional

7-100 | 7-115 | 7-115 E | 7-125

 **BOSCH**

de Originalbetriebsanleitung	el Πρωτότυπο οδηγιών χρήσης
en Original instructions	tr Orijinal işletme talimatı
fr Notice originale	ar تعليمات التشغيل الأصلية
es Manual original	fa راهنمای طرز کار اصلی
pt Manual original	
it Istruzioni originali	
nl Oorspronkelijke gebruiksaanwijzing	
da Original brugsanvisning	
sv Bruksanvisning i original	
no Original driftsinstruks	
fi Alkuperäiset ohjeet	



4 |

5 |

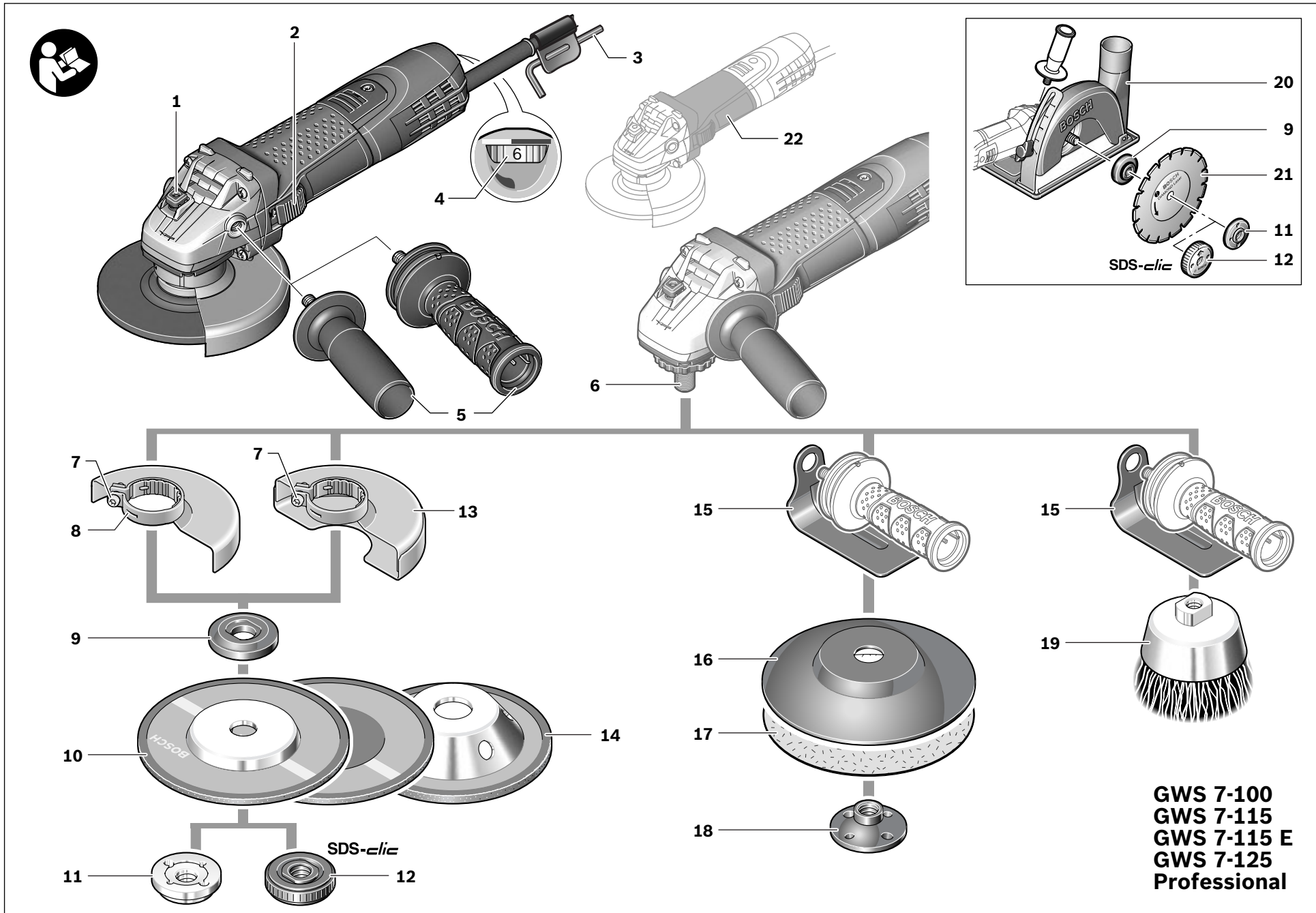

Safety Notes

General Power Tool Safety Warnings

⚠ WARNING Read all safety warnings and all instructions. Failure to follow the warnings and instructions may result in electric shock, fire and/or serious injury.

Save all warnings and instructions for future reference.

The term “power tool” in the warnings refers to your mains-operated (corded) power tool or battery-operated (cordless) power tool.

1) Work area safety

- a) **Keep work area clean and well lit.** Cluttered or dark areas invite accidents.
- b) **Do not operate power tools in explosive atmospheres, such as in the presence of flammable liquids, gases or dust.** Power tools create sparks which may ignite the dust or fumes.
- c) **Keep children and bystanders away while operating a power tool.** Distractions can cause you to lose control.

2) Electrical safety

- a) **Power tool plugs must match the outlet. Never modify the plug in any way. Do not use any adapter plugs with earthed (grounded) power tools.** Unmodified plugs and matching outlets will reduce risk of electric shock.
- b) **Avoid body contact with earthed or grounded surfaces, such as pipes, radiators, ranges and refrigerators.** There is an increased risk of electric shock if your body is earthed or grounded.
- c) **Do not expose power tools to rain or wet conditions.** Water entering a power tool will increase the risk of electric shock.
- d) **Do not abuse the cord. Never use the cord for carrying, pulling or unplugging the power tool. Keep cord away from heat, oil, sharp edges and moving parts.** Damaged or entangled cords increase the risk of electric shock.

e) **When operating a power tool outdoors, use an extension cord suitable for outdoor use.** Use of a cord suitable for outdoor use reduces the risk of electric shock.

f) **If operating a power tool in a damp location is unavoidable, use a residual current device (RCD) protected supply.** Use of an RCD reduces the risk of electric shock.

3) Personal safety

- a) **Stay alert, watch what you are doing and use common sense when operating a power tool. Do not use a power tool while you are tired or under the influence of drugs, alcohol or medication.** A moment of inattention while operating power tools may result in serious personal injury.
- b) **Use personal protective equipment. Always wear eye protection.** Protective equipment such as dust mask, non-skid safety shoes, hard hat, or hearing protection used for appropriate conditions will reduce personal injuries.
- c) **Prevent unintentional starting. Ensure the switch is in the off-position before connecting to power source and/or battery pack, picking up or carrying the tool.** Carrying power tools with your finger on the switch or energising power tools that have the switch on invites accidents.
- d) **Remove any adjusting key or wrench before turning the power tool on.** A wrench or a key left attached to a rotating part of the power tool may result in personal injury.
- e) **Do not overreach. Keep proper footing and balance at all times.** This enables better control of the power tool in unexpected situations.
- f) **Dress properly. Do not wear loose clothing or jewellery. Keep your hair, clothing and gloves away from moving parts.** Loose clothes, jewellery or long hair can be caught in moving parts.

g) If devices are provided for the connection of dust extraction and collection facilities, ensure these are connected and properly used. Use of dust collection can reduce dust-related hazards.

4) Power tool use and care

a) Do not force the power tool. Use the correct power tool for your application. The correct power tool will do the job better and safer at the rate for which it was designed.

b) Do not use the power tool if the switch does not turn it on and off. Any power tool that cannot be controlled with the switch is dangerous and must be repaired.

c) Disconnect the plug from the power source and/or the battery pack from the power tool before making any adjustments, changing accessories, or storing power tools. Such preventive safety measures reduce the risk of starting the power tool accidentally.

d) Store idle power tools out of the reach of children and do not allow persons unfamiliar with the power tool or these instructions to operate the power tool.

Power tools are dangerous in the hands of untrained users.

e) Maintain power tools. Check for misalignment or binding of moving parts, breakage of parts and any other condition that may affect the power tool's operation. If damaged, have the power tool repaired before use. Many accidents are caused by poorly maintained power tools.

f) Keep cutting tools sharp and clean. Properly maintained cutting tools with sharp cutting edges are less likely to bind and are easier to control.

g) Use the power tool, accessories and tool bits etc. in accordance with these instructions, taking into account the working conditions and the work to be performed. Use of the power tool for operations different from those intended could result in a hazardous situation.

5) Service

a) Have your power tool serviced by a qualified repair person using only identical replacement parts. This will ensure that the safety of the power tool is maintained.

Safety Warnings for Angle Grinder

Safety Warnings common for Grinding, Sanding, Wire Brushing or Abrasive Cutting Off Operations

▶ **This power tool is intended to function as a grinder, sander, wire brush or cut-off tool. Read all safety warnings, instructions, illustrations and specifications provided with this power tool.** Failure to follow all instructions listed below may result in electric shock, fire and/or serious injury.

▶ **This power tool is not recommended for polishing.** Operations for which the power tool was not designed may create a hazard and cause personal injury.

▶ **Do not use accessories which are not specifically designed and recommended by the tool manufacturer.** Just because the accessory can be attached to your power tool, it does not assure safe operation.

▶ **The rated speed of the accessory must be at least equal to the maximum speed marked on the power tool.** Accessories running faster than their rated speed can break and fly apart.

▶ **The outside diameter and the thickness of your accessory must be within the capacity rating of your power tool.** Incorrectly sized accessories cannot be adequately guarded or controlled.

▶ **The arbor size of wheels, flanges, backing pads or any other accessory must properly fit the spindle of the power tool.** Accessories with arbor holes that do not match the mounting hardware of the power tool will run out of balance, vibrate excessively and may cause loss of control.

- ▶ **Do not use a damaged accessory.** Before each use inspect the accessory such as abrasive wheels for chips and cracks, backing pad for cracks, tear or excess wear, wire brush for loose or cracked wires. If power tool or accessory is dropped, inspect for damage or install an undamaged accessory. After inspecting and installing an accessory, position yourself and bystanders away from the plane of the rotating accessory and run the power tool at maximum no-load speed for one minute. Damaged accessories will normally break apart during this test time.
 - ▶ **Wear personal protective equipment.** Depending on application, use face shield, safety goggles or safety glasses. As appropriate, wear dust mask, hearing protectors, gloves and workshop apron capable of stopping small abrasive or workpiece fragments. The eye protection must be capable of stopping flying debris generated by various operations. The dust mask or respirator must be capable of filtering particles generated by your operation. Prolonged exposure to high intensity noise may cause hearing loss.
 - ▶ **Keep bystanders a safe distance away from work area. Anyone entering the work area must wear personal protective equipment.** Fragments of workpiece or of a broken accessory may fly away and cause injury beyond immediate area of operation.
 - ▶ **Hold power tool by insulated gripping surfaces only, when performing an operation where the cutting accessory may contact hidden wiring or its own cord.** Cutting accessory contacting a "live" wire may make exposed metal parts of the power tool "live" and shock the operator.
 - ▶ **Position the cord clear of the spinning accessory.** If you lose control of the power tool, the cord may be cut or snagged and your hand or arm may be pulled into the spinning accessory.
 - ▶ **Never lay the power tool down until the accessory has come to a complete stop.** The spinning accessory may grab the surface and pull the power tool out of your control.
 - ▶ **Do not run the power tool while carrying it at your side.** Accidental contact with the spinning accessory could snag your clothing, pulling the accessory into your body.
 - ▶ **Regularly clean the power tool's air vents.** The motor's fan will draw the dust inside the housing and excessive accumulation of powdered metal may cause electrical hazards.
 - ▶ **Do not operate the power tool near flammable materials.** Sparks could ignite these materials.
 - ▶ **Do not use accessories that require liquid coolants.** Using water or other liquid coolants may result in electrocution or shock.
- Kickback and related warnings**
- ▶ Kickback is a sudden reaction to a pinched or snagged rotating wheel, backing pad, brush or any other accessory. Pinching or snagging causes rapid stalling of the rotating accessory which in turn causes the uncontrolled power tool to be forced in the direction opposite of the accessory's rotation at the point of the binding.
For example, if an abrasive wheel is snagged or pinched by the workpiece, the edge of the wheel that is entering into the pinch point can dig into the surface of the material causing the wheel to climb out or kick out. The wheel may either jump toward or away from the operator, depending on direction of the wheel's movement at the point of pinching. Abrasive wheels may also break under these conditions.
Kickback is the result of power tool misuse and/or incorrect operating procedures or conditions and can be avoided by taking proper precautions as given below.

24 | English

- ▶ **Maintain a firm grip on the power tool and position your body and arm to allow you to resist kickback forces. Always use auxiliary handle, if provided, for maximum control over kickback or torque reaction during start-up.** The operator can control torque reactions or kickback forces, if proper precautions are taken.
- ▶ **Never place your hand near the rotating accessory.** Accessory may kickback over your hand.
- ▶ **Do not position your body in the area where power tool will move if kickback occurs.** Kickback will propel the tool in direction opposite to the wheel's movement at the point of snagging.
- ▶ **Use special care when working corners, sharp edges, etc. Avoid bouncing and snagging the accessory.** Corners, sharp edges or bouncing have a tendency to snag the rotating accessory and cause loss of control or kickback.
- ▶ **Do not attach a saw chain woodcarving blade or toothed saw blade.** Such blades create frequent kickback and loss of control over the power tool.
- ▶ **Always use undamaged wheel flanges that are of correct size and shape for your selected wheel.** Proper wheel flanges support the wheel thus reducing the possibility of wheel breakage. Flanges for cut-off wheels may be different from grinding wheel flanges.
- ▶ **Do not use worn down wheels from larger power tools.** Wheels intended for larger power tools are not suitable for the higher speed of a smaller tool and may burst.

Additional safety warnings specific for abrasive cutting off operations

- ▶ **Do not "jam" the cut-off wheel or apply excessive pressure. Do not attempt to make an excessive depth of cut.** Overstressing the wheel increases the loading and susceptibility to twisting or binding of the wheel in the cut and the possibility of kickback or wheel breakage.
 - ▶ **Do not position your body in line with and behind the rotating wheel.** When the wheel, at the point of operation, is moving away from your body, the possible kickback may propel the spinning wheel and the power tool directly at you.
 - ▶ **When wheel is binding or when interrupting a cut for any reason, switch off the power tool and hold the power tool motionless until the wheel comes to a complete stop. Never attempt to remove the cut-off wheel from the cut while the wheel is in motion otherwise kickback may occur.** Investigate and take corrective action to eliminate the cause of wheel binding.
 - ▶ **Do not restart the cutting operation in the workpiece. Let the wheel reach full speed and carefully reenter the cut.** The wheel may bind, walk up or kickback if the power tool is restarted in the workpiece.
 - ▶ **Support panels or any oversized workpiece to minimize the risk of wheel pinching and kickback.** Large workpieces tend to sag under their own weight. Supports must be placed under the workpiece near the line of cut and near the edge of the workpiece on both sides of the wheel.
- Additional safety instructions for grinding and cutting off operations**
- ▶ **Use only wheel types that are recommended for your power tool and the specific guard designed for the selected wheel.** Wheels for which the power tool was not designed cannot be adequately guarded and are unsafe.
 - ▶ **The guard must be securely attached to the power tool and positioned for maximum safety, so the least amount of wheel is exposed towards the operator.** The guard helps to protect operator from broken wheel fragments and accidental contact with wheel.
 - ▶ **Wheels must be used only for recommended applications. For example: do not grind with the side of the cut-off wheel.** Abrasive cut-off wheels are intended for peripheral grinding; side forces applied to these wheels may cause them to shatter.

- ▶ **Use extra caution when making a “pocket cut” into existing walls or other blind areas.** The protruding wheel may cut gas or water pipes, electrical wiring or objects that can cause kickback.

Safety warnings specific for sanding operations

- ▶ **Do not use excessively oversized sanding disc paper. Follow manufacturers recommendations, when selecting sanding paper.** Larger sanding paper extending beyond the sanding pad presents a laceration hazard and may cause snagging, tearing of the disc, or kickback.

Safety warnings specific for wire brushing operations

- ▶ **Be aware that wire bristles are thrown by the brush even during ordinary operation. Do not overstress the wires by applying excessive load to the brush.** The wire bristles can easily penetrate light clothing and/or skin.
- ▶ **If the use of a guard is recommended for wire brushing, do not allow any interference of the wire wheel or brush with the guard.** Wire wheel or brush may expand in diameter due to work load and centrifugal forces.

Additional safety warnings



Wear safety goggles.

- ▶ **Use suitable detectors to determine if utility lines are hidden in the work area or call the local utility company for assistance.** Contact with electric lines can lead to fire and electric shock. Damaging a gas line can lead to explosion. Penetrating a water line causes property damage or may cause an electric shock.

- ▶ **Release the On/Off switch and set it to the off position when the power supply is interrupted, e. g., in case of a power failure or when the mains plug is pulled.** This prevents uncontrolled restarting.

- ▶ **When working stone, use dust extraction. The vacuum cleaner must be approved for the extraction of stone dust.** Using this equipment reduces dust-related hazards.

- ▶ **Use a cutting guide when cutting stone.** Without sideward guidance, the cutting disc can jam and cause kickback.

- ▶ **When working with the machine, always hold it firmly with both hands and provide for a secure stance.** The power tool is guided more secure with both hands.

- ▶ **Secure the workpiece.** A workpiece clamped with clamping devices or in a vice is held more secure than by hand.

- ▶ **Keep your workplace clean.** Blends of materials are particularly dangerous. Dust from light alloys can burn or explode.

- ▶ **Never use the machine with a damaged cable. Do not touch the damaged cable and pull the mains plug when the cable is damaged while working.** Damaged cables increase the risk of an electric shock.

Products sold in GB only: Your product is fitted with an BS 1363/A approved electric plug with internal fuse (ASTA approved to BS 1362).

If the plug is not suitable for your socket outlets, it should be cut off and an appropriate plug fitted in its place by an authorised customer service agent. The replacement plug should have the same fuse rating as the original plug.

The severed plug must be disposed of to avoid a possible shock hazard and should never be inserted into a mains socket elsewhere.

Products sold in AUS and NZ only: Use a residual current device (RCD) with a rated residual current of 30 mA or less.

Functional Description



Read all safety warnings and all instructions. Failure to follow the warnings and instructions may result in electric shock, fire and/or serious injury.

While reading the operating instructions, unfold the graphics page for the machine and leave it open.

Intended Use

The machine is intended for cutting, roughing, and brushing metal and stone materials without using water.

For cutting metal, a special protection guard for cutting (accessory) must be used.

For cutting stone, a special extraction hood for cutting with cutting guide (accessory) must be used.

With approved sanding tools, the machine can be used for sanding with sanding discs.

Product Features

The numbering of the product features refers to the illustration of the machine on the graphics page.

- 1 Spindle lock button
- 2 On/Off switch
- 3 Allen key
- 4 Thumbwheel for speed preselection (GWS 7-115 E)
- 5 Auxiliary handle
- 6 Grinder spindle
- 7 Locking screw for protection guard
- 8 Protection guard for grinding
- 9 Mounting flange with O-ring
- 10 Grinding/cutting disc*
- 11 Clamping nut
- 12 Quick-clamping nut **SDS-clic** *
- 13 Protection guard for cutting*
- 14 Carbide grinding head*
- 15 Hand guard*
- 16 Rubber sanding plate*
- 17 Sanding sheet*

18 Round nut*

19 Cup brush*

20 Cutting guide with dust extraction protection guard*

21 Diamond cutting disc*

22 Handle (insulated gripping surface)

***Accessories shown or described are not part of the standard delivery scope of the product. A complete overview of accessories can be found in our accessories program.**

Technical Data

Angle Grinder		GWS 7-100 Professional	GWS 7-115 Professional	GWS 7-115 E Professional	GWS 7-125 Professional
Article number		3 601 C88 1..	3 601 C88 1..	3 601 C88 2..	3 601 C88 1..
Rated power input	W	720	720	720	720
Rated speed	min ⁻¹	11000	11000	11000	11000
Speed control adjustment	min ⁻¹	–	–	2800 – 11000	–
Grinding disc diameter, max.	mm	100	115	115	125
Thread of grinder spindle		M 10	M 14	M 14	M 14
Thread length (max.) of grinder spindle	mm	17	22	22	22
Weight according to EPTA-Procedure 01/2003	kg	1.8	1.9	1.9	1.9
Protection class		□/II	□/II	□/II	□/II

The values given are valid for nominal voltages [U] of 230/240 V. For lower voltage and models for specific countries, these values can vary.

Please observe the article number on the type plate of your machine. The trade names of the individual machines may vary.

Noise/Vibration Information

Measured sound values determined according to EN 60745.

Typically the A-weighted noise levels of the product are: Sound pressure level 91 dB(A); Sound power level 102 dB(A). Uncertainty K = 3 dB.

Wear hearing protection!

Vibration total values (triax vector sum) determined according to EN 60745:

Surface grinding: Vibration emission value

$a_h = 6.5 \text{ m/s}^2$, Uncertainty $K = 1.5 \text{ m/s}^2$,

Disk sanding: Vibration emission value

$a_h = 3.5 \text{ m/s}^2$, Uncertainty $K = 1.5 \text{ m/s}^2$.

The vibration emission level given in this information sheet has been measured in accordance with a standardised test given in EN 60745 and may be used to compare one tool with another. It may be used for a preliminary assessment of exposure.

The declared vibration emission level represents the main applications of the tool. However if the tool is used for different applications, with

different accessories or poorly maintained, the vibration emission may differ. This may significantly increase the exposure level over the total working period.

An estimation of the level of exposure to vibration should also take into account the times when the tool is switched off or when it is running but not actually doing the job. This may significantly reduce the exposure level over the total working period.

Identify additional safety measures to protect the operator from the effects of vibration such as: maintain the tool and the accessories, keep the hands warm, organisation of work patterns.

Declaration of Conformity

We declare under our sole responsibility that the product described under "Technical Data" is in conformity with the following standards or standardization documents: EN 60745 according to the provisions of the directives 2004/108/EC, 98/37/EC (until 28 Dec 2009), 2006/42/EC (from 29 Dec 2009).

Technical file at:
Robert Bosch GmbH, PT/ESC,
D-70745 Leinfelden-Echterdingen

Dr. Egbert Schneider Senior Vice President
Engineering

Dr. Eckerhard Strötgen Head of Product
Certification

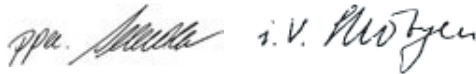

Robert Bosch GmbH, Power Tools Division
D-70745 Leinfelden-Echterdingen
25.09.2009

Assembly

Mounting the Protective Devices

- ▶ **Before any work on the machine itself, pull the mains plug.**

Note: After breakage of the grinding disc during operation or damage to the holding fixtures on the protection guard/power tool, the machine must promptly be sent to an after-sales service agent for maintenance (for addresses, see section „After-sales Service and Customer Assistance“).

Protection Guard for Grinding

Place the protection guard **8** on the spindle collar. Adjust the position of the protection guard **8** to the requirements of the operation. Lock the protection guard **8** tightening the locking screw **7** with an allen key **3**.

- ▶ **Adjust the protection guard 8 in such a manner that sparking is prevented in the direction of the operator.**

Note: The encoding keys on the protection guard **8** ensure that only a protection guard that fits the machine type can be mounted.

Protection Guard for Cutting

- ▶ **For cutting metal, always work with the protection guard for cutting **13**.**
- ▶ **For cutting stone, always work with the cutting guide with dust extraction protection guard **20**.**

The protection guard for cutting **13** is mounted in the same manner as the protection guard for grinding **8**.

Auxiliary Handle

- ▶ **Operate your machine only with the auxiliary handle **5**.**

Screw the auxiliary handle **5** on the right or left of the machine head depending on the working method.

Vibration-dampening Auxiliary Handle



The vibration-dampening auxiliary handle reduces the vibrations, making operation more comfortable and secure.

- ▶ **Do not make any alterations to the auxiliary handle.**

Do not continue to use an auxiliary handle if it is damaged.

Hand Guard

- ▶ **For operations with the rubber sanding plate **16** or with the cup brush/wheel brush/flap disc, always mount the hand guard **15**.**

The hand guard **15** is fastened with the auxiliary handle **5**.

Mounting the Grinding Tools

- ▶ **Before any work on the machine itself, pull the mains plug.**
- ▶ **Grinding and cutting discs become very hot while working; do not touch until they have cooled.**

Clean the grinder spindle **6** and all parts to be mounted.

For clamping and loosening the grinding tools, lock the grinder spindle with the spindle lock button **1**.

- ▶ **Actuate the spindle lock button only when the grinder spindle is at a standstill.** Otherwise, the machine may become damaged.

Grinding/Cutting Disc

Pay attention to the dimensions of the grinding tools. The mounting hole diameter must fit the mounting flange without play. Do not use reducers or adapters.

When using diamond cutting discs, pay attention that the direction-of-rotation arrow on the diamond cutting disc and the direction of rotation of the machine (see direction-of-rotation arrow on the machine head) agree.

See graphics page for the mounting sequence.

To fasten the grinding/cutting disc, screw on the clamping nut **11** and tighten with the two-pin spanner; see Section "Quick-clamping Nut".

- ▶ **After mounting the grinding tool and before switching on, check that the grinding tool is correctly mounted and that it can turn freely. Make sure that the grinding tool does not graze against the protection guard or other parts.**

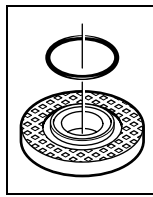

Mounting flange for grinding spindle M 14: An O-ring (plastic part) is inserted in the mounting flange **9** around the centring collar. **If the O-ring is missing or is damaged, it must in all cases be replaced (article number 1 600 210 039)** before the mounting flange **9** is mounted.

the mounting flange **9** is mounted.

Mounting flange for grinding spindle M 10: The mounting flange can be used on both sides.

Flap Disc

- ▶ **For operations with the flap disc, always mount the hand guard 15.**

Rubber Sanding Plate

- ▶ **For operations with the rubber sanding plate 16, always mount the hand guard 15.**

See graphics page for the mounting sequence.

Screw on the round nut **18** and tighten with the two-pin spanner.

Cup Brush/Disc Brush

- ▶ **For operations with the cup brush/wheel brush, always mount the hand guard 15.**

See graphics page for the mounting sequence.

The cup brush/disc brush must be able to be screwed onto the grinder spindle until it rests firmly against the grinder spindle flange at the end of the grinder spindle threads. Tighten the cup brush/disc brush with an open-end spanner.

Quick-clamping Nut *SDS-elic*

For convenient changing of grinding tools without the use of additional tools, you can use the quick-clamping nut **12** instead of the clamping nut **11**.

- ▶ **The quick-clamping nut 12 may be used only for grinding or cutting discs.**

Use only a flawless, undamaged quick-clamping nut 12.

When screwing on, pay attention that the side of the quick-clamping nut 12 with printing does not face the grinding disc; the arrow must point to the index mark 23.

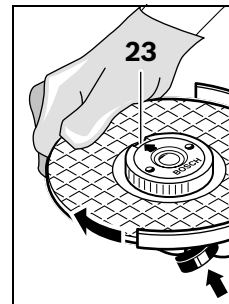

Lock the grinder spindle with the spindle lock button **1**. To tighten the quick-clamping nut, firmly turn the grinding disc in clockwise direction.

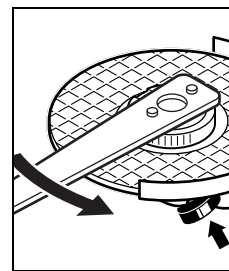

A properly attached, undamaged quick-clamping nut can be loosened by hand when turning the knurled ring in anti-clockwise direction. **Never loosen a tight quick-clamping nut with pliers. Always use the two-pin spanner.**



Insert the two-pin spanner as shown in the illustration.

Approved Grinding Tools

All grinding tools mentioned in these operating instructions can be used.

The permissible speed [min^{-1}] or the circumferential speed [m/s] of the grinding tools used must at least match the values given in the table.

Therefore, observe the permissible **rotational/circumferential speed** on the label of the grinding tool.

	max. [mm]		[mm]	[min^{-1}]	[m/s]
	D	b			
	100	6	16.0	11000	80
	115	6	22.2	11000	80
	125	6	22.2	11000	80
	100	-	-	11000	80
	115	-	-	11000	80
	125	-	-	11000	80
	70	30	M 10	11000	45
	75	30	M 14	11000	45

Rotating the Machine Head

- ▶ **Before any work on the machine itself, pull the mains plug.**

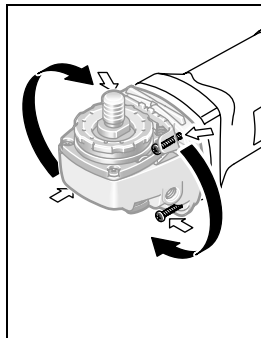

The machine head can be rotated with respect to the machine housing in 90° steps. In this manner, the On/Off switch can be brought into a more convenient position for special working situations, e.g. for left-handed persons.

Completely unscrew the four screws. Rotate the machine head carefully, **without removing it from the housing**, to the new position. Screw in and tighten the four screws again.

Dust/Chip Extraction

- ▶ Dusts from materials such as lead-containing coatings, some wood types, minerals and metal can be harmful to one's health. Touching or breathing-in the dusts can cause allergic reactions and/or lead to respiratory infections of the user or bystanders.

Certain dusts, such as oak or beech dust, are considered as carcinogenic, especially in connection with wood-treatment additives (chromate, wood preservative). Materials containing asbestos may only be worked by specialists.

- Use dust extraction whenever possible.
- Provide for good ventilation of the working place.
- It is recommended to wear a P2 filter-class respirator.

Observe the relevant regulations in your country for the materials to be worked.

Operation

Starting Operation

- ▶ **Observe correct mains voltage! The voltage of the power source must agree with the voltage specified on the nameplate of the machine. Power tools marked with 230 V can also be operated with 220 V.**
- ▶ **Hold power tool by insulated gripping surfaces 22 and auxiliary handle 5 only. The accessory may contact hidden wiring or its own cord.** Accessory contacting a "live" wire may make exposed metal parts of the power tool "live" and shock the operator.

When operating the machine with power from mobile generators that do not have sufficient reserve capacity or are not equipped with suitable voltage control with starting current amplification, loss of performance or untypical behavior can occur upon switching on.

Please observe the suitability of the power generator being used, particularly with regard to the mains voltage and frequency.

Switching On and Off

To **start** the power tool, push the On/Off switch **2** forwards.

To **lock** the On/Off switch **2**, press the On/Off switch **2** down at the front until it latches.

To **switch off** the power tool, release the On/Off switch **2** or, if it is locked, briefly push down the back of the On/Off switch **2** and then release it.

- ▶ **Check grinding tools before using. The grinding tool must be mounted properly and be able to move freely. Carry out a test run for at least one minute with no load. Do not use damaged, out-of-centre or vibrating grinding tools.** Damaged grinding tools can burst and cause injuries.

Speed preselection (GWS 7-115 E)

The required speed can be preselected with the thumbwheel **4** (also while running).

The data in the following table are recommended values.

Material	Application	Accessory	Thumbwheel Position
Metal	Removing paint	Sanding disc	2 – 3
Wood, metal	Brushing, rust removal	Cup brush, sanding disc	3
Metal, masonry	Grinding	Grinding disc	4 – 6
Metal	Rough grinding	Grinding disc	6
Masonry, stone	Cutting	Cutting disc and cutting guide (Cutting masonry/stone is permitted only with use of the cutting guide)	6

Working Advice

- ▶ **Exercise caution when cutting slots in structural walls; see Section “Information on Structures”.**
- ▶ **Clamp the workpiece if it does not remain stationary due to its own weight.**
- ▶ **Do not strain the machine so heavily that it comes to a standstill.**
- ▶ **After heavily straining the power tool, continue to run it at no-load for several minutes to cool down the cutting/grinding tool.**
- ▶ **Grinding and cutting discs become very hot while working; do not touch until they have cooled.**
- ▶ **Do not use the power tool with a cut-off stand.**

Rough Grinding

- ▶ **Never use a cutting disc for roughing.**

The best roughing results are achieved when setting the machine at an angle of 30° to 40°. Move the machine back and forth with moderate pressure. In this manner, the workpiece will not become too hot, does not discolour and no grooves are formed.

Flap Disc

With the flap disc (accessory), curved surfaces and profiles can be worked.

Flap discs have a considerably higher service life, lower noise levels and lower sanding temperatures than conventional sanding sheets.

Cutting Metal

- ▶ **For cutting metal, always work with the protection guard for cutting 13.**

32 | English

When cutting, work with moderate feed, adapted to the material being cut. Do not exert pressure onto the cutting disc, tilt or oscillate the machine.

Do not reduce the speed of running down cutting discs by applying sideward pressure.

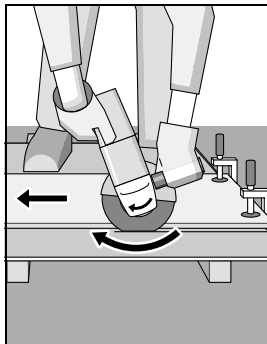

The machine must always work in an up-grinding motion. Otherwise, the danger exists of it being pushed **uncontrolled** out of the cut.

When cutting profiles and square bar, it is best to start at the smallest cross section.

Cutting Stone

- ▶ **For cutting stone, always work with the cutting guide with dust extraction protection guard 20.**
- ▶ **The machine may be used only for dry cutting/grinding.**

For cutting stone, it is best to use a diamond cutting disc. As a safety measure against jamming, the cutting guide with dust extraction protection guard **20** must be used.

Operate the machine only with dust extraction and additionally wear a dust protection mask.

The vacuum cleaner must be approved for the extraction of masonry dust. Bosch provides suitable vacuum cleaners.

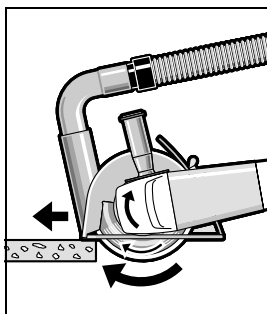

Switch on the machine and place the front part of the cutting guide on the workpiece. Slide the machine with moderate feed, adapted to the material to be worked.

For cutting especially hard material, e. g., concrete with high pebble content, the diamond cutting disc can overheat and become damaged as a result. This is clearly indicated by circular sparking, rotating with the diamond cutting disc.

In this case, interrupt the cutting process and allow the diamond cutting disc to cool by running the machine for a short time at maximum speed with no load.

Noticeable decreasing work progress and circular sparking are indications of a diamond cutting disc that has become dull. Briefly cutting into abrasive material (e. g. lime-sand brick) can resharpen the disc again.

Information on Structures

Slots in structural walls are subject to the Standard DIN 1053 Part 1, or country-specific regulations.

These regulations are to be observed under all circumstances. Before beginning work, consult the responsible structural engineer, architect or the construction supervisor.

Maintenance and Service

Maintenance and Cleaning

- ▶ **Before any work on the machine itself, pull the mains plug.**
- ▶ **For safe and proper working, always keep the machine and ventilation slots clean.**
- ▶ **In extreme conditions, always use dust extraction as far as possible. Blow out ventilation slots frequently and install a residual current device (RCD).** When working metals, conductive dust can settle in the interior of the power tool. The total insulation of the power tool can be impaired.

Please store and handle the accessory(-ies) carefully.

If the machine should fail despite the care taken in manufacturing and testing procedures, repair should be carried out by an after-sales service centre for Bosch power tools.

In all correspondence and spare parts order, please always include the 10-digit article number given on the type plate of the machine.

After-sales Service and Customer Assistance

Our after-sales service responds to your questions concerning maintenance and repair of your product as well as spare parts. Exploded views and information on spare parts can also be found under:

www.bosch-pt.com

Our customer service representatives can answer your questions concerning possible applications and adjustment of products and accessories.

Great Britain

Robert Bosch Ltd. (B.S.C.)
P.O. Box 98
Broadwater Park
North Orbital Road
Denham
Uxbridge
UB 9 5HJ
Tel. Service: +44 (0844) 736 0109
Fax: +44 (0844) 736 0146
E-Mail: boschservicecentre@bosch.com

Ireland

Origo Ltd.
Unit 23 Magna Drive
Magna Business Park
City West
Dublin 24
Tel. Service: +353 (01) 4 66 67 00
Fax: +353 (01) 4 66 68 88

Australia, New Zealand and Pacific Islands

Robert Bosch Australia Pty. Ltd.
Power Tools
Locked Bag 66
Clayton South VIC 3169
Customer Contact Center
Inside Australia:
Phone: +61 (01300) 307 044
Fax: +61 (01300) 307 045
Inside New Zealand:
Phone: +64 (0800) 543 353
Fax: +64 (0800) 428 570
Outside AU and NZ:
Phone: +61 (03) 9541 5555
www.bosch.com.au

Republic of South Africa

Customer service

Hotline: +27 (011) 6 51 96 00

Gauteng – BSC Service Centre

35 Roper Street, New Centre
Johannesburg
Tel.: +27 (011) 4 93 93 75
Fax: +27 (011) 4 93 01 26
E-Mail: bsctools@icon.co.za

KZN – BSC Service Centre

Unit E, Almar Centre
143 Crompton Street
Pinetown
Tel.: +27 (031) 7 01 21 20
Fax: +27 (031) 7 01 24 46
E-Mail: bsc.dur@za.bosch.com

Western Cape – BSC Service Centre

Democracy Way, Prosperity Park
Milnerton
Tel.: +27 (021) 5 51 25 77
Fax: +27 (021) 5 51 32 23
E-Mail: bsc@zsd.co.za

Bosch Headquarters

Midrand, Gauteng
Tel.: +27 (011) 6 51 96 00
Fax: +27 (011) 6 51 98 80
E-Mail: rbsa-hq.pts@za.bosch.com

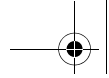

Disposal

The machine, accessories and packaging should be sorted for environmental-friendly recycling.

Only for EC countries:



Do not dispose of power tools into household waste!

According the European Guideline 2002/96/EC for Waste Electrical and Electronic Equipment and its implementation into national

right, power tools that are no longer usable must be collected separately and disposed of in an environmentally correct manner.

Subject to change without notice.

